

REMOVE VERTICAL WIRES A DISTANCE OF 6" AT EACH END OF A 12" FENCE LAP AND ATTACH HORIZONTAL WIRES BY TWISTING THIS 6' TAIL TO OTHER FENCING.

TENSION CABLES (SEE NOTE #1 SHEET 2 OF 2)

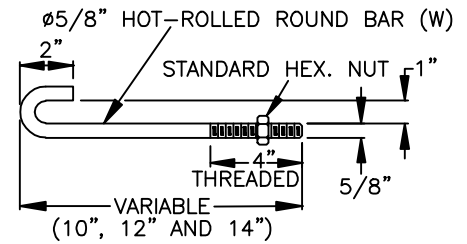

DETAIL OF FENCE AND CABLE FASTENINGS

ROUND J-BOLT DETAIL

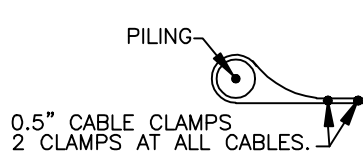

END PILING DETAIL

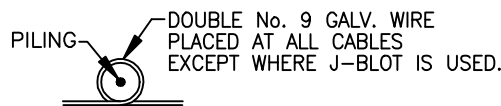

WIRE FASTENER

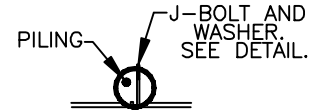

PILING J-BOLT

PLAN

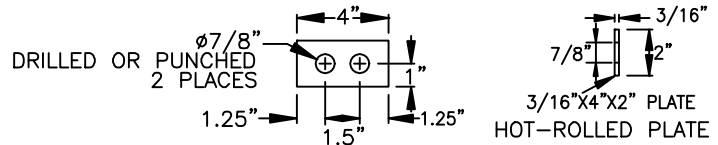
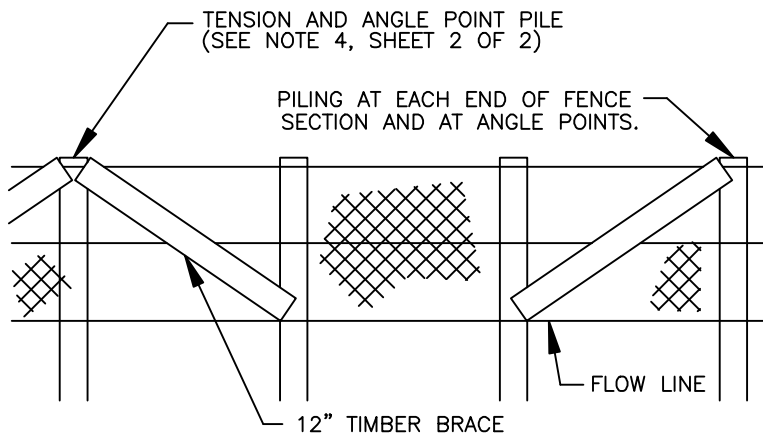
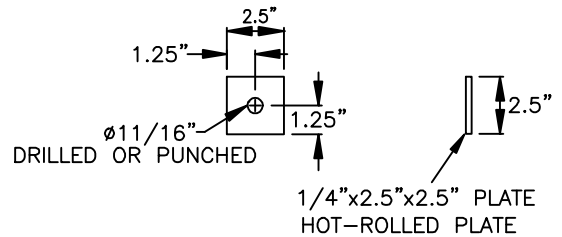

PLATE DETAIL



BRACE DETAIL



J-BOLT DETAIL

NOTES:

1. FOR GENERAL NOTES AND ADDITIONAL DETAILS SEE SHEET 2 OF 2.

CITY OF CHINO HILLS

CHRIS VOGT
CITY ENGINEER

TIMBER PILE FENCING

SD101

1 OF 2